

# TILE-EZ

# MODEL 4260-C

SCALE: 3/4

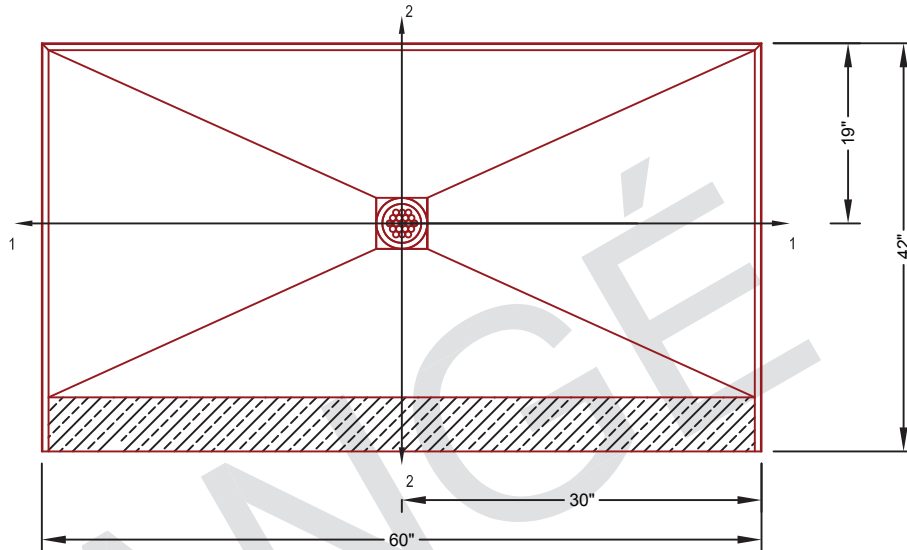

ANGÉ TILE-EZ SHOWER PAN WITH CURB

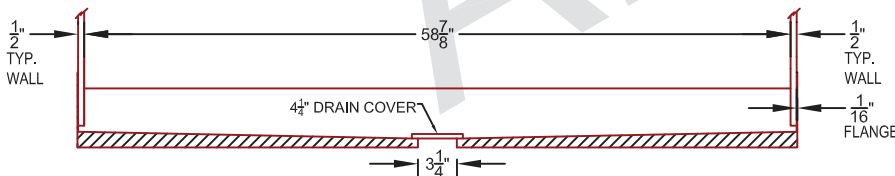

CROSS SECTION 1.1

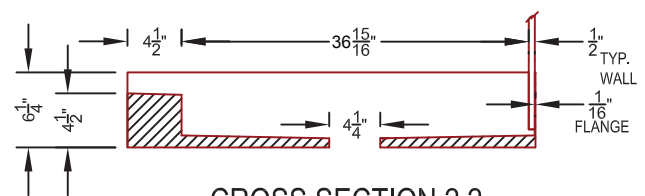

CROSS SECTION 2.2

## Product Features:

- Tile-EZ Shower Receptor (ANSI Z-124.1/Z-124.2) with integrated curb and flange system – Guaranteed not to Leak!
- Floor pre-sloped 1/4" per foot to drain opening.
- Tile set directly on pan and curb surfaces with water based thin-set (Tile-EZ Approved). No epoxies or time-sensitive tile setting materials are required.
- Opening for 2" drain provides easy connection with Tile-EZ PVC Glue-In Assembly. (Optional Tile-EZ Compression Assembly available for slab installations and where access to plumbing is limited).
- Round polished chrome strainer (optional round strainer finishes available). Optional square drain covers available with compression drain connection (PVC or brass).
- Tile-EZ Flange System permits use with typical 1/2" conventional wall cement board.
- No liner, special adhesives, or mud setting required for installation.



Technical Support / Questions  
Tel: 856-673-8747  
Fax: 856-235-5410  
Email: ANGEPAN@Tile-EZ.COM

[www.Tile-EZ.com](http://www.Tile-EZ.com)

