

TILE-EZ

MODEL 4242-C

SCALE: 3/4

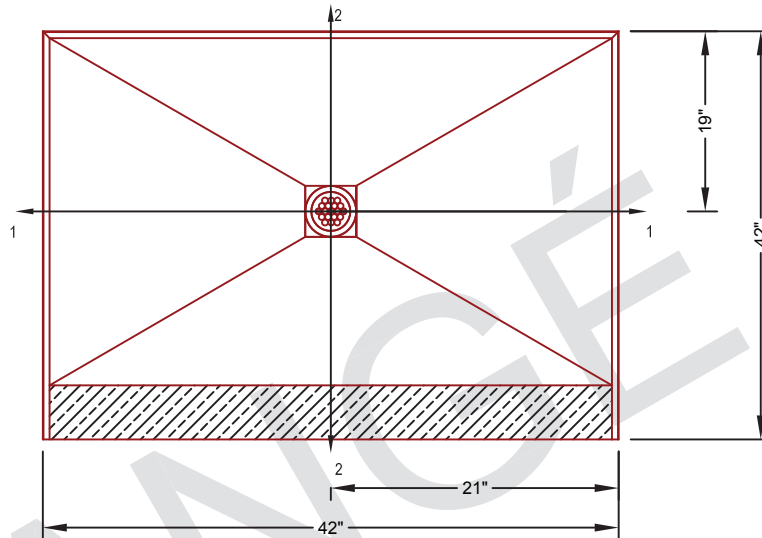

ANGÉ TILE-EZ SHOWER PAN WITH CURB

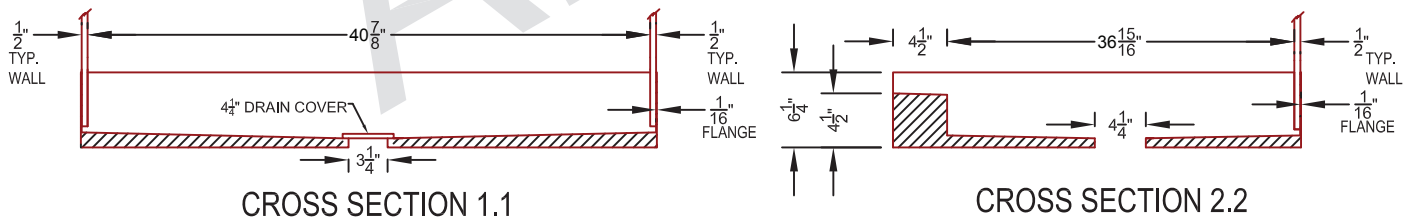

CROSS SECTION 1.1

CROSS SECTION 2.2

Product Features:

- Tile-EZ Shower Receptor (ANSI Z-124.1/Z-124.2) with integrated curb and flange system – Guaranteed not to Leak!
- Floor pre-sloped $\frac{1}{4}$ " per foot to drain opening.
- Tile set directly on pan and curb surfaces with water based thin-set (Tile-EZ Approved). No epoxies or time-sensitive tile setting materials are required.
- Opening for 2" drain provides easy connection with Tile-EZ PVC Glue-In Assembly. (Optional Tile-EZ Compression Assembly available for slab installations and where access to plumbing is limited).
- Round polished chrome strainer (optional round strainer finishes available). Optional square drain covers available with compression drain connection (PVC or brass).
- Tile-EZ Flange System permits use with typical $\frac{1}{2}$ " conventional wall cement board.
- No liner, special adhesives, or mud setting required for installation.



Technical Support / Questions
Tel: 856-673-8747
Fax: 856-235-5410
Email: ANGEPAN@Tile-EZ.COM

www.Tile-EZ.com

